

New Reali-Slim TT™ Series

Precision Thin-Section Ball Bearings

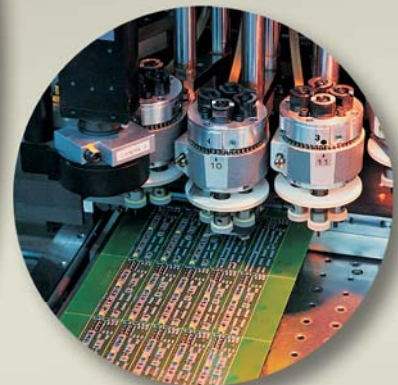

TURNING IDEAS INTO ENGINEERED SOLUTIONS

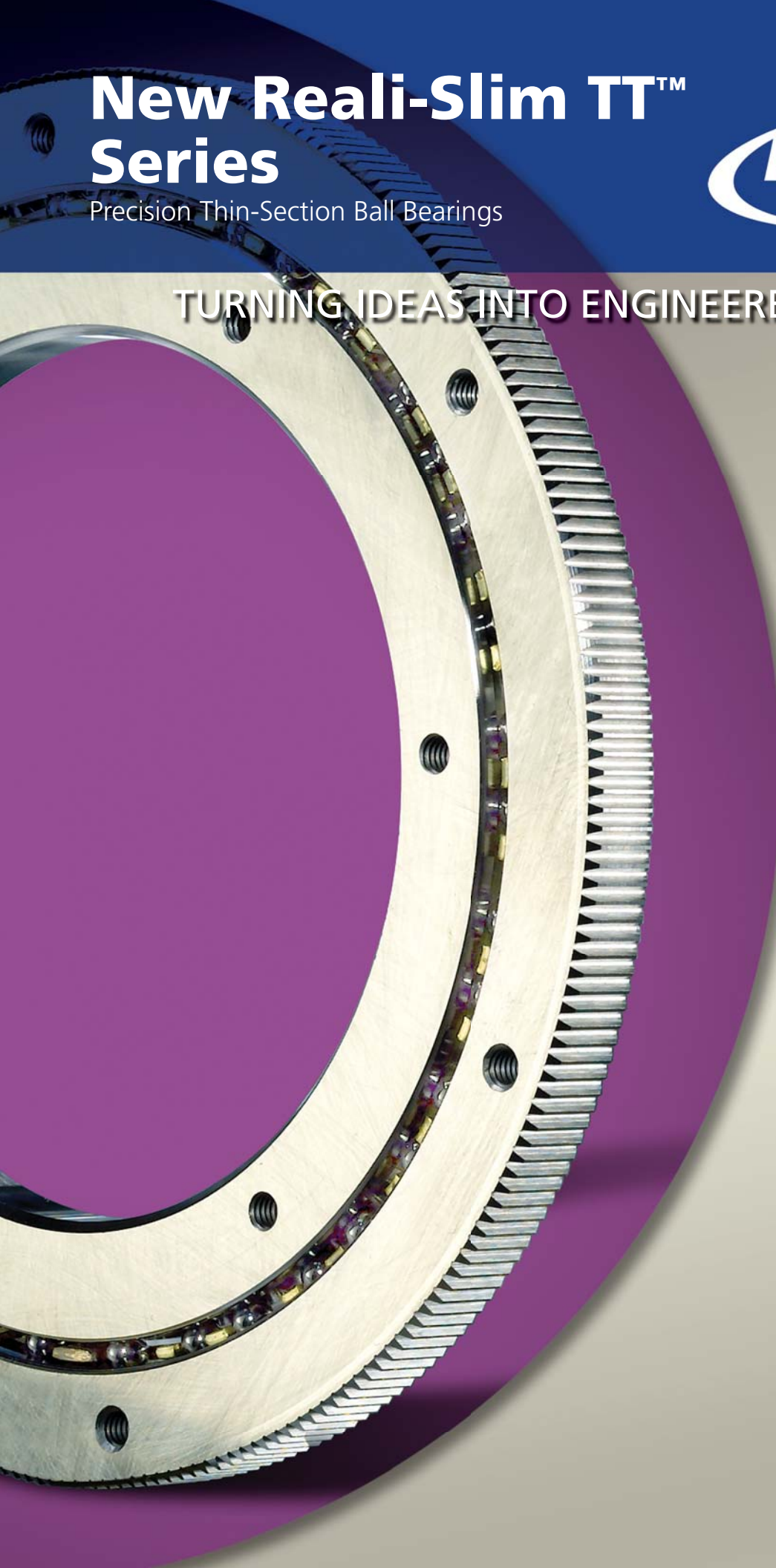

Only from Kaydon® Bearings: the new generation of miniature turntable bearings

To save weight, reduce product design envelope sizes and increase design flexibility — without compromising bearing performance and life — customers told us they'd welcome a more compact turntable bearing design.

We listened and responded, by designing the first miniature, thin-section turntable bearings available for such demanding applications as robotics, radar antennae, and factory positioning and inspection tables... Reali-Slim TT™ Series. The advantages of this new Series vs. conventional turntable bearings include:

- significantly smaller size for greater design versatility and reduced weight (smallest bore size is 1.5 inches, largest O.D. is 7.5 inches, only .25 inches high);
- greater accuracy — extended radial bearing section increases rigidity, and optional preload or clearances to meet application torque or deflection requirements;
- easier to use — fast installation and changeout;
- custom configurations to meet your application's specific needs — many drive options, gearing/timing belt, mounting hole types; and
- designed to withstand harsh operating environments — AISI-440C steel races, steel reinforced seals.

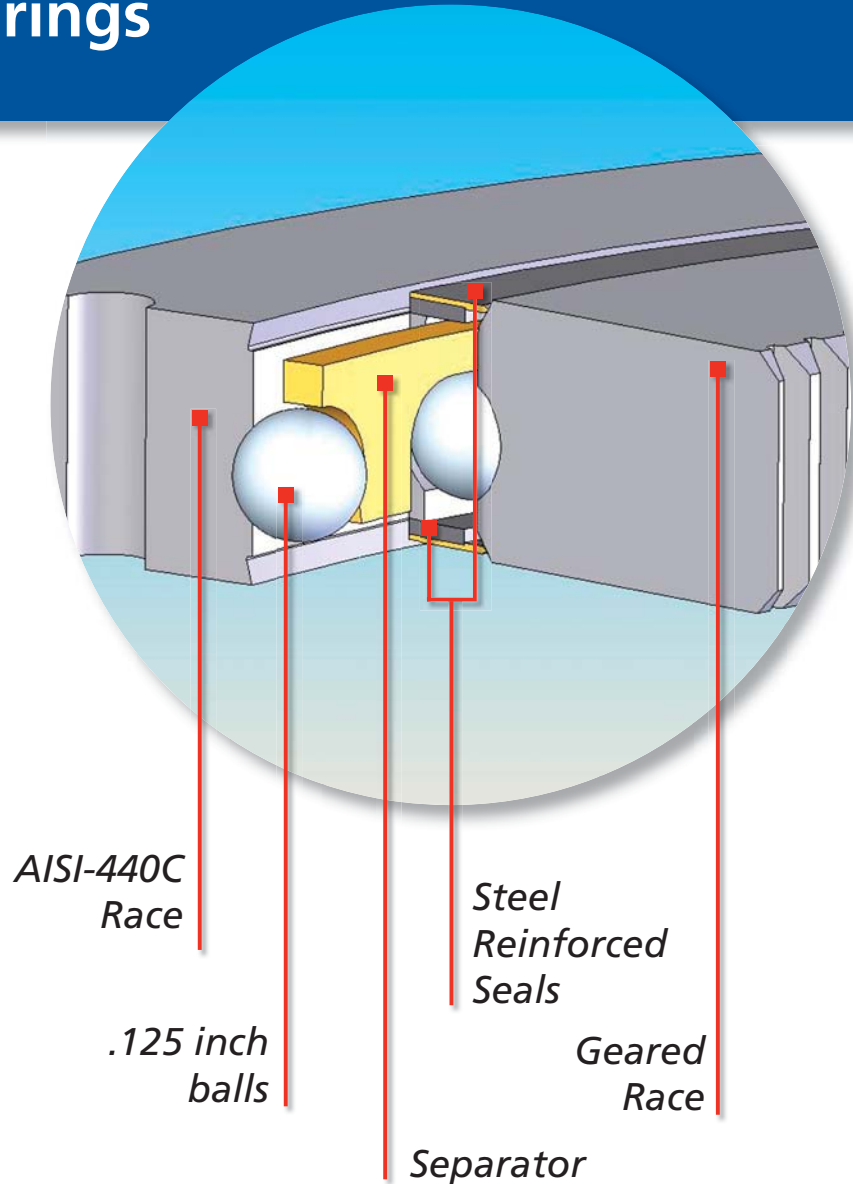

The configurations and specifications you need for more compact, more precise turntable designs

Example of part number breakdown

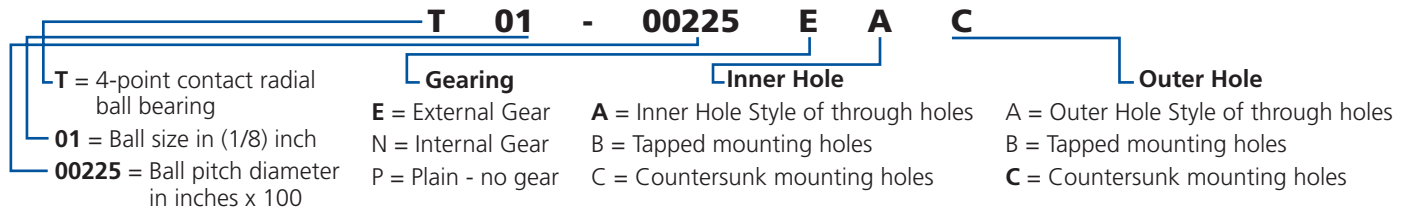

Holes sized for #4-40 screws, tapped, countersunk, or through gears set at full depth involute, 64 DP, 20 degree pressure angle

Four-Point Contact Bearing (Reali-Slim TT™ Series)

Lines are most often designed to handle either radial or axial load conditions. The unique feature about the Kaydon Reali-Slim TT™ Series four-point contact bearing line is that the gothic arch geometry of the inner and outer races enables a single bearing to carry three types of loading (radial, axial and moment) simultaneously. This makes it the bearing of choice for many

applications since a single four-point contact bearing can often replace two bearings, providing a simplified design.

Reali-Slim TT™ Series bearings may also be furnished with an internal diametral preload for those applications requiring greater stiffness or zero free play. This is accomplished by using balls that are larger than the space provided in the raceways. The

balls and raceways, therefore, have some elastic deformation in the absence of an external load.

Reali-Slim TT™ Series

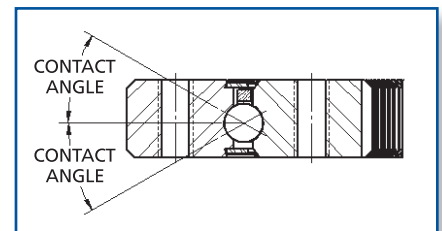

Basic Part Number	Radial (lbs.)		Thrust (lbs.)		Moment (in. - lbs.)		Static Torque (in. - lbs.)	Weight (lbs.)
	Static	Dynamic	Static	Dynamic	Static	Dynamic		
T01-00225	680	320	1,710	790	770	360	3.4	0.35
T01-00275	830	360	2,090	910	1,150	500	4.4	0.43
T01-00325	990	410	2,470	1,010	1,600	660	5.5	0.50
T01-00375	1,140	450	2,850	1,110	2,130	840	6.5	0.59
T01-00425	1,290	480	3,220	1,210	2,740	1,030	7.4	0.67
T01-00450	1,370	500	3,410	1,260	3,070	1,130	7.9	0.70
T01-00475	1,440	520	3,600	1,310	3,420	1,240	8.5	0.74
T01-00500	1,520	540	3,790	1,350	3,790	1,350	9.0	0.78
T01-00525	1,590	560	3,980	1,400	4,180	1,460	9.5	0.82
T01-00575	1,750	590	4,360	1,480	5,020	1,700	10.4	0.89
T01-00625	1,900	630	4,740	1,570	5,930	1,960	11.3	0.98
T01-00675	2,050	660	5,120	1,650	6,910	2,230	12.2	1.05

Torque based on seal drag in addition to a light preload

Note: Reali-Slim TT™ Series turntable bearings are custom designed to meet your application's needs. Ask your Kaydon representative for delivery leadtimes.

Non-geared Bearings

Part Number with Through Holes	Bore	O.D.	Inner Land	Outer Land	Inner Bolt Circle	Number of holes	Outer Bolt Circle	Number of holes
T01-00225PAA	1.500	3.000	2.148	2.356	1.813	6	2.688	8
T01-00275PAA	2.000	3.500	2.648	2.856	2.313	8	3.188	10
T01-00325PAA	2.500	4.000	3.148	3.356	2.813	9	3.688	12
T01-00375PAA	3.000	4.500	3.648	3.856	3.313	10	4.188	14
T01-00425PAA	3.500	5.000	4.148	4.356	3.813	12	4.688	15
T01-00450PAA	3.750	5.250	4.398	4.606	4.063	12	4.938	16
T01-00475PAA	4.000	5.500	4.648	4.856	4.313	14	5.188	16
T01-00500PAA	4.250	5.750	4.898	5.106	4.563	14	5.438	18
T01-00525PAA	4.500	6.000	5.148	5.356	4.813	15	5.688	18
T01-00575PAA	5.000	6.500	5.648	5.856	5.313	16	6.188	20
T01-00625PAA	5.500	7.000	6.148	6.356	5.813	18	6.688	22
T01-00675PAA	6.000	7.500	6.648	6.856	6.313	20	7.188	22

Externally Geared Bearings

Part Number with Through Holes	Bore	Gear O.D.	Inner Land	Outer Land	Inner Bolt Circle	Number of holes	Outer Bolt Circle	Number of holes	Gear Pitch Dia.	Number of teeth
T01-00225EAA	1.500	3.078	2.148	2.356	1.813	6	2.688	8	3.047	195
T01-00275EAA	2.000	3.578	2.648	2.856	2.313	8	3.188	10	3.547	227
T01-00325EAA	2.500	4.078	3.148	3.356	2.813	9	3.688	12	4.047	259
T01-00375EAA	3.000	4.578	3.648	3.856	3.313	10	4.188	14	4.547	291
T01-00425EAA	3.500	5.078	4.148	4.356	3.813	12	4.688	15	5.047	323
T01-00450EAA	3.750	5.328	4.398	4.606	4.063	12	4.938	16	5.297	339
T01-00475EAA	4.000	5.578	4.648	4.856	4.313	14	5.188	16	5.547	355
T01-00500EAA	4.250	5.828	4.898	5.106	4.563	14	5.438	18	5.797	371
T01-00525EAA	4.500	6.078	5.148	5.356	4.813	15	5.688	18	6.047	387
T01-00575EAA	5.000	6.578	5.648	5.856	5.313	16	6.188	20	6.547	419
T01-00625EAA	5.500	7.078	6.148	6.356	5.813	18	6.688	22	7.047	451
T01-00675EAA	6.000	7.578	6.648	6.856	6.313	20	7.188	22	7.547	483

Internally Geared Bearings

Part Number with Through Holes	Gear I.D.	O.D.	Inner Land	Outer Land	Inner Bolt Circle	Number of holes	Outer Bolt Circle	Number of holes	Gear Pitch Dia.	Number of teeth
T01-00225NAA	1.422	3.000	2.148	2.356	1.813	6	2.688	8	1.453	93
T01-00275NAA	1.922	3.500	2.648	2.856	2.313	8	3.188	10	1.953	125
T01-00325NAA	2.422	4.000	3.148	3.356	2.813	9	3.688	12	2.453	157
T01-00375NAA	2.922	4.500	3.648	3.856	3.313	10	4.188	14	2.953	189
T01-00425NAA	3.422	5.000	4.148	4.356	3.813	12	4.688	15	3.453	221
T01-00450NAA	3.672	5.250	4.398	4.606	4.063	12	4.938	16	3.703	237
T01-00475NAA	3.922	5.500	4.648	4.856	4.313	14	5.188	16	3.953	253
T01-00500NAA	4.172	5.750	4.898	5.106	4.563	14	5.438	18	4.203	269
T01-00525NAA	4.422	6.000	5.148	5.356	4.813	15	5.688	18	4.453	285
T01-00575NAA	4.922	6.500	5.648	5.856	5.313	16	6.188	20	4.953	317
T01-00625NAA	5.422	7.000	6.148	6.356	5.813	18	6.688	22	5.453	349
T01-00675NAA	5.922	7.500	6.648	6.856	6.313	20	7.188	22	5.953	381

The design features and options you asked for

Custom Reali-Slim TT™ Series thin-section bearings are the proven, single 4-point contact ball radial design, consisting of a single row of balls with a unique gothic arch raceway and brass separators for low frictional torque. Radial, axial and moment load-capable, the bearings are prelubricated and ready for use; simply position the bearings on the mounting face and tighten the mounting screws! Bearing versions available with optional internal or external spur gear for ease of drive setup, or non-gear designs.

Geared options are 64 diametral pitch with 20° pressure angle, up to AGMA Class 10, and provide low-backlash service. Built-in seals are a low-torque design, and made of rugged, reliable steel-reinforced nitrile rubber.

Mounting holes are sized for #4-40 UNC fasteners with optional styles — .136 through holes and countersunk holes, and tapped through. Non-gear races have mounting piloting diameters controlled to .0008 inches.

The bearings are cleaned and packaged in a Class 10,000 clean room; Class 100 clean room standards are also available.



No gear with through holes

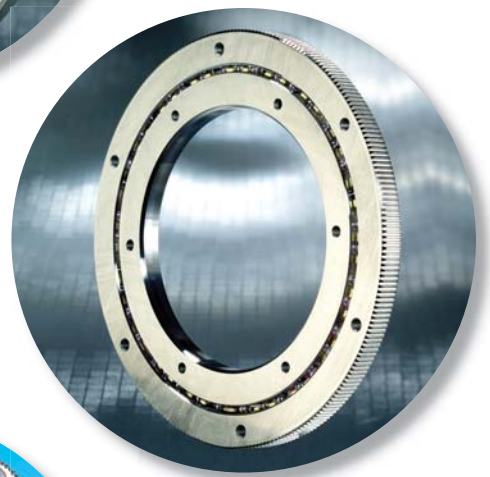

External gear with tapped holes

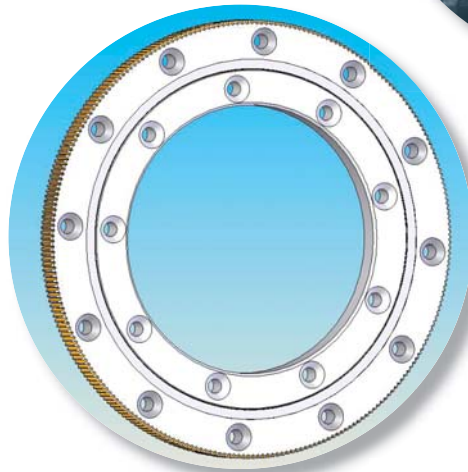

Externally geared bearing with countersunk holes

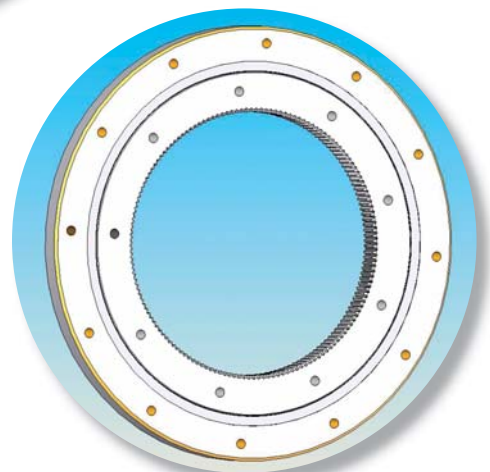

Internal gear with tapped holes



Kaydon® Corporation
2860 McCracken Street
Muskegon, Michigan 49441 U.S.A.
Phone: (231) 755-3741
Fax: (231) 759-4102

Need Service Fast?
1-800-514-3066

Visit our website: www.kaydonbearings.com